

WATTCCON

Dosing and Control Equipment Catalogue

January 2009

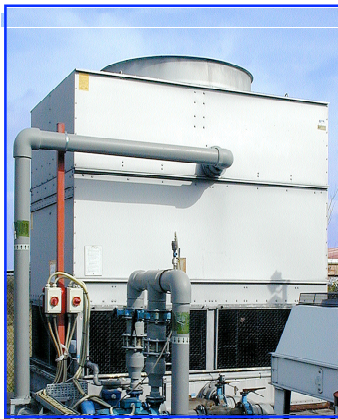

Wattcon
20 Ali Akilu Road
(Zadina Plaza)
PO Box 8808
Kaduna
Nigeria

Tel: 234.62.213585
Fax: 234.62.213585
E-mail: info@wattcon.com

WATTCCON Equipment Catalogue Index

Index

Accessories for Red Electronic Dosing Pump	Page 17
Accessories for Motor Driven Dosing Pumps	Page 23
Air operated Dosing Pumps	Page 16
Back Plate systems	Page 12
Boiler water controllers	Page 13
Brominators	Page 11
Bunds Tanks	Page 20
Chlorine Residual Instruments	Page 9
Chlorine Residual Cells	Page 9
Conductivity Control Kits	Page 1
Cooling Water Control	Page 10
Corrosion Racks	Page 11
Control Valves pneumatic	Page 24
Dissolved Oxygen Controllers	Page 3
Dissolved Oxygen sensors	Page 3
Dosing Controllers	Page 8
Dosing Pumps Electronic Red Series F, G & V	Page 14
Dosing Pumps Electronic Red Series CMS & H	Page 15
Dosing Pumps Electronic Red Specials	Page 16
Dosing Pump Electronic Red Accessories	Page 17
Dosing Pump Electronic Red Spares F,G,H, & V	Page 18
Dosing Pump Electronic Red Spares CMS	Page 19
Dosing Pumps Motor Driven	Page 23
Dosing Tanks & Bunds	Page 20
IBC Bunds	Page 21
Mixers Geared	Page 22
Mixers High Speed	Page 22
Peristaltic Pumps	Page 25
Pneumatic Pumps	Page 25
Storage Tanks	Page 21
Solenoid Valves Brass & Plastic	Page 24
Solution Strength & Electrodeless Conductivity	Page 2
Storage tank monitoring Instruments	Page 21
Swimming Pool Controllers & Sensors	Page 6
Turbidity Controllers & Cells	Page 4
Transfer Pumps Pneumatic	Page 25
Water Meters	Page 7

Chemical dosing of hazardous chemicals acid or alkali is dangerous. WATTCCON recommend any pump be installed inside a sealed enclosure and any chemically dosing lines should be installed inside a second chemical resistant tube or pipe. An injection fitting should be shielded so in the unfortunate event of a leakage of any chemical there is no risk whatsoever of persons coming into contact with any chemicals being dosed or mixed. This should also provide mechanical protection for the dosing equipment.

The wetted parts of the dosing pumps and hoses are clearly listed, please check with your chemical supplier the suitability of the materials for handling the chemicals in use. WATTCCON or its suppliers accept no liability of our products as being suitable for handling any chemical or mixture of chemicals. For more concentrated chemicals we are able to offer PVDF heads, PTFE ball valves and PVDF dosing hoses.

Conductivity Control Kits from WATTCCON

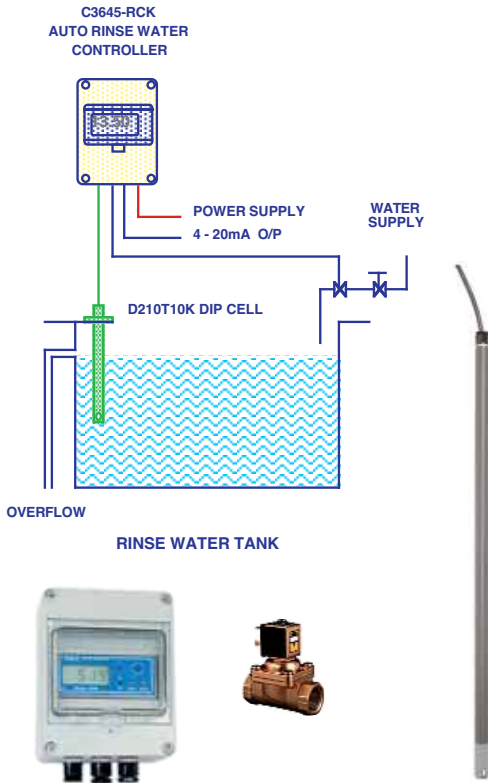

Auto Rinse Water Control Kits

The metal finishing industry uses vast quantities of both towns and demin water to rinse components after chemical processing. Savings in water can be achieved by only adding water when the rinse tank is contaminated which can be controlled by conductivity.

C3645-RC Auto rinse control kit Controller C3645-W
Ranges 0-200 μ S, 0-2,000 μ S & 0-20mS with
ATC and 4-20 mA current output.
D210T10KF 600mm long dip cell fitted
auto temp comp, mounting flange & 3 m
connecting cable, max solution temp 50 °C
Brass solenoid valve 1/2" B.S.P. with w'proof
coil.

As above with BSV075-00 Brass solenoid
valve 3/4" B.S.P. with w'proof coil.

Solution Strength Control Kits

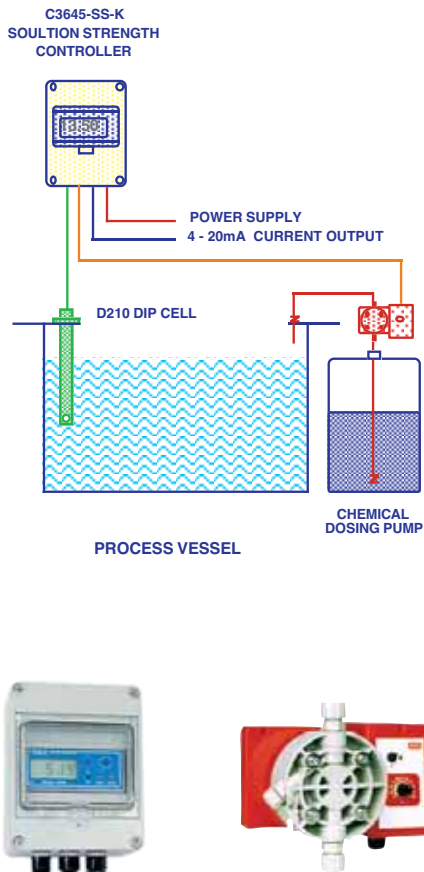

C3645-SSK Conductivity controller with digital display, set
point with delay timer and current output of
4-20 mA. Range 0-20mS fitted auto temp comp
in surface mounting enclosure with
D210F 600mm long dip conductivity cell in
PVC fitted with flange & 3 m connecting cable
max temp 50 °C

GCO 05-15 dosing pump 0-15 L/Hr against
5 bar with polypropylene head teflon diaphragm
ceramic valves and PVC/LDPE dosing hoses
with foot valve and injection valve

C3645-010-SSK

As above but range 0 - 200 mS with
D410T10KF 600mm long dip conductivity cell
in PVDF fitted auto temp comp mounting
flange & 3 m connecting cable, max solution
temp 100 °C

GCO 05-15 dosing pump 0-15 L/Hr against
5 bar with polypropylene head teflon diaphragm
ceramic valves and PVC/LDPE dosing hoses
with foot valve and injection valve

**Kits can be made up with any of our cells or pumps
to suit your application please call our office for prices.**

Electrodeless Conductivity Control from WATTCCON

Conductivity at 25°C in milliseimens

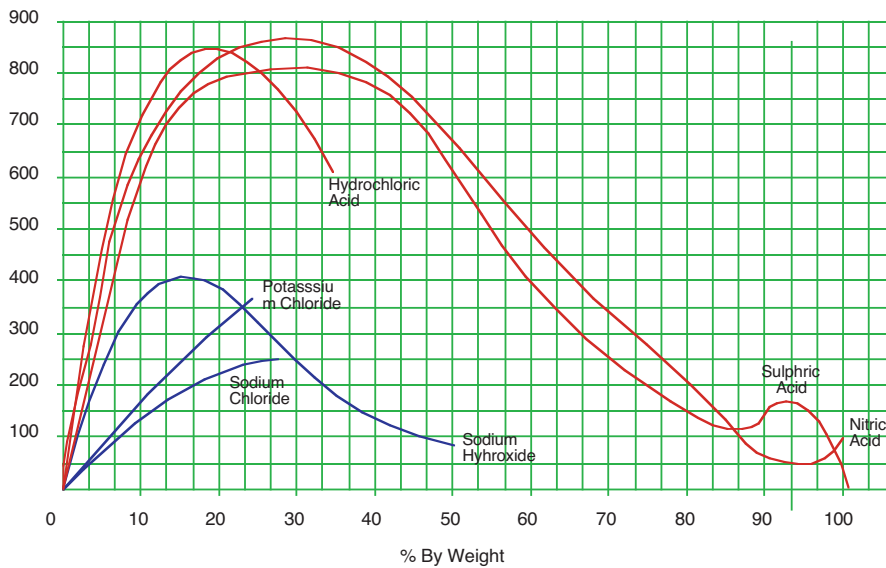

Electrodeless Conductivity Control

The strength of weak acid and alkali solutions may be accurately controlled by using conductivity. As the solution strength increases the electrical resistance decreases (conductivity is the reciprocal of resistance). Care must be taken as most solutions reach a peak where the conductivity decreases again. This is shown on our enclosed graph. Our electrodeless conductivity systems feature sensors which are unaffected by fouling. Typical applications are the control of processing solutions in the metal finishing industry and the control of CIP solutions in the food industry.



C3655W Electrodeless or (Torroidal) conductivity controller in surface mounting enclosure with digital display set point with delay timer & 4 - 20 mA. output Ranges 0 - 20, 0 - 200 or 0 - 2000mS. (factory set.) DEC1 600 mm dip cell in PVDF. with PP riser tube fitted ATC, flange & 2 m cable max temp 85 °C.

- MS Mark space timer & larger enclosure allows time for mixing
- PVDF PVDF cell riser tube max temp 100°C
- SS Stainless steel cell riser tube max temp 100°C

Concentration Indicator & Controller

C7685W-K Conductivity controller with 2 set points, alarm relay delay timers & isolated output . Manual or auto ranging from 0-20, 0-200 or 0-2000 mS, Programmable concentration range in either %, mg/L or Baume' fitted ATC DEC1 600 mm long dip cell in PVDF. with PP riser tube flange & micro transmitter preamplifier

- PVDF PVDF cell riser tube max temp 100 °C
- SS Stainless steel cell riser tube max temp 100 °C
- LMK7 Connecting cable METC to C7685 per metre

Electrodeless Conductivity Cells.

- SI315 Electrodeless cell in PVDF (Kynar) with Auto Temp Comp Via Pt100
 - SI315.I Electrodeless cell as above with DN32 Taper fitting to DIN 1185.52
 - SZ724 Stainless steel collar and clamp ring assembly for Brewery / Dairy use
 - RTPVC Riser tube in PVC 100 mm long connects Micro transmitter to Cell
 - RTPP-F Riser tube in polypropylene up to 1000 mm long with PVC mounting flange
 - RTPVDF-F Riser tube in PVDF up to 1000 mm long with PP adapter
 - RTSS-F Riser tube in Stainless steel up to 1000 mm long with PP adapter
- Other mountings can be supplied to order

Dissolved Oxygen Controllers from WATTCCON

Panel Mounting Controllers

- OD7685 Panel mounting DO2 meter which will display Oxygen in ppm, % saturation or mg/L. with automatic temp comp and temperature display.
Two control relays, alarm relay with delay timer and isolated current output, Optional auto cleaning of the sensor maybe accomplished or a preset time with freeze and holds of the last reading and control functions.
- W W'proof enclosure to hold 1 or 2 7600 instruments (add)
- DES 1 Dip DO2 sensor 1800 mm with j-box & mounting flange spare membranes & filling solution.
- PF Polypropylene float approx 600 mm dia with mounting for DES1 with mounting lugs for use in lagoons and sumps where there is large change in the liquid level.
- AC Auto clean compressed air sensor cleaning system comprising of a small 240 volt air compressor solenoid and regulating valves with air blast nozzle includes option auto clean function in the instrument
- DES-1SK Spares kit to refurbish DES1 sensor
- LMK6 Dissolved oxygen connecting cable per metre length



DO² Simulator

- OD105 DO² simulator for calibrating the instrument and checking the operation of Polarographic (Clark) type DO² cells.
Note using a simulator does not eliminate the need to calibrate the sensor.

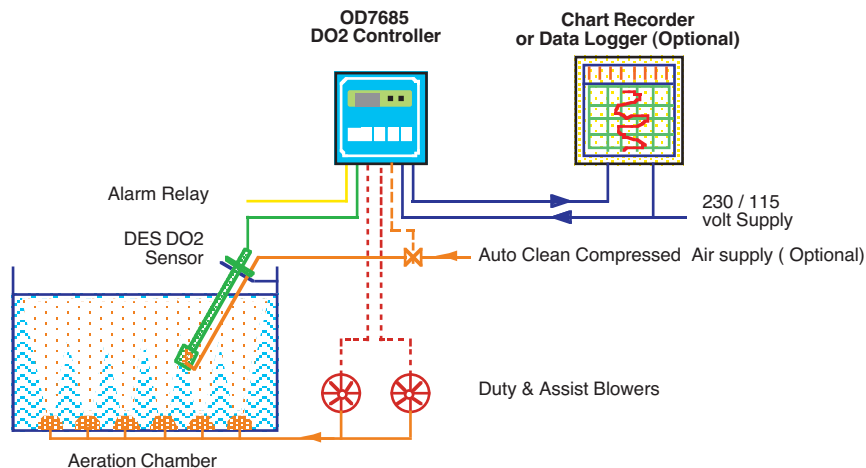

Turbidity Contollers from WATTCCON

Panel Mounting Controllers

TU7685 Turbidity meter based on the Nephelometric method of measurment auto or manual range selection form 0 - 4.00, 0 - 40.00, 0 - 400.0 or 0 - 4000. NTU with two control relays one alarm relay and an isolated current output. The TU7685 is for use with the TU800 Infrared light sensor which carries out the measurement. The sensor maybe mounted up to 100 metres away from the TU7685 Turbidity meter.



-W W'proof enclosure to hold 1 or 2 7600 instruments (add)

Three types of sensor are available

TU800 -F Off line flow cell in PVC for a small flowing sample of 0.25 to 25 litres/min. connection by 8 mm OD tubing max temperature 30°C

TU800 -I Inline mounting with a 2" PVC tee to form part of a 2" line.

TU800 -D Dip sensor 600mm long with PVC riser tube and mounting flange .

TU910 10 metre long connecting cable with wproof connectors

-AC Dip sensors can be supplied with an auto clean compressed air sensor cleaning system comprising of a small 240 volt air compressor solenoid and regulating valves with air blast nozzel includes option auto clean function in the instrument.



Surface Mounting Controller

LDTORB Surface mounting μ P turbidity controller ranges up to 300 NTU with 2 control relays , alarm relay and isolated current output.

ETORB/1000 Dip Turbidity sensor 600 mm long in Stainless steel with PVC riser tube and mounting flange with auto clean by mechanical wiper max temp 40°C fitted 20 m connecting cable

The ETORB/1000 can also be supplied for mounting into a large diameter PVC Tee. Precise mounting can be built to suit your requirements



Swimming Pool Controllers from WATTCCON

For the control and dosing of swimming pools we are able to offer several options to suit the size and usage of the pool. From simple systems using pH and Redox control for acid and hypochlorite dosing to full microprocessor system measuring pH, mV, residual chlorine and turbidity with communication options.



Pumps with Built-in Controller

- VMS PH Dosing pump for measurement and Proportional pH control 0 -14.00 pH with built-in low level control Output 0 - 5 L/Hr against 5 bar
- VMS RH Dosing pump for measurement and Proportional Redox (ORP) control 0-1000 mV with built-in low level control. fitted PVDF head and valves
- NPED2 Off line sensor holder with removable bowl to hold 9015 and 9016 electrodes
- 9015 -10B Plastic bodied pH combination electrode
- 9016 -10B Plastic bodied Redox combination electrode
- NIFL60 Filter with washable cartridge 60 μ fitting 8 x 12 mm hose connections
- NCA60 Filter cartridge 60 μ for NIFL60



Combined Controller & Pumps

- EPHRHD Combined dual controller and dual dosing pumps for pH (acid dosing) and ORP (disinfectant dosing) output 0 - 5 L/Hr either independent feeding or acid priority (version with one pump and brominator output is available)
- NPED2 Off line sensor holder with removable bowl to hold 9015 and 9016 electrodes
- 9015 -10B Plastic bodied pH combination electrode
- 9016 -10B Plastic bodied Redox combination electrode
- NIFL60 Filter with washable cartridge 60 μ fitting 8 x 12 mm hose connections
- NCA60 Filter cartridge 60 μ for NIFL60

pH & Amperometric Chlorine Controller



- LPHCL/4 Controller with dual displays, 0-14.00 pH and 0-10 mg/L CL₂ with two on/off control relays and two 0-20mA current outputs
- ECL6 Free chlorine amperometric cell (organic & inorganic) with copper and platinum electrodes with mini VA flow indicator and proximity switch mounting for 9015-10B combination pH electrode
- 9015 -10B Plastic bodied pH combination electrode
- SEPR. Proximity switch to suit flow cell PEF1/E
- NIFL60 Filter with washable cartridge 60 μ fitting 8 x 12 mm hose connections
- NCA60 Filter cartridge 60 μ for NIFL60

Swimming Pool Controllers from WATTCCON



pH & Amperometric Chlorine Controller

- LPHCLD Surface mounting microprocessor based pH and chlorine controller 0-14.00 pH and 0-5mg/L CL2 LCD backlight display with two control relays offering on/off or PWM control for acid and hypochlorite dosing pump and two 0-20mA current outputs.
- PEF1 Model PEF1 electrode holder to hold pH and chlorine sensors with mini VA flow indicator and porximity switch mounting
- SEPR. Proximity switch to suit flow cell PEF1/E
- ELC1/5 Free Chlorine amperometric cell with membrane, range 0-5.00 mg/L with auto temperature compensation
- 9015 -10B Plastic bodied pH combination electrode
- NIFL60 Filter with washable cartridge 60 μ fitting 8 x 12 mm hose connections
- NCA60 Filter cartridge 60 μ for NIFL60







pH, mV, Chlorine & Turbidity Controller

- WQCT pH, ORP potential and Cl₂ controller for remote control, with temperature reading, provided with temperature probe. It is equipped with a serial port to connect a standard modem easily available in the market or a GSM modem for installation in remote places where there is not the phone line. The instrument can also be programmed to call the data center's PC to notify the presence of an alarm. Remote control software is provided with the controller.
- PEF1 Off line sensor holder with mini VA flow indicator, needle valve to hold sensor type ECL1, 2, 3 proximity switch mounting
- SEPR. Proximity switch to suit flow cell PEF1/E
- ELC1/5 Free Chlorine amperometric cell with membrane, range 0-5.00 mg/L with auto temperature compensation
- 9015 -10B Plastic bodied pH combination electrode
- 9016 -10B Plastic bodied Redox combination electrode
- ETORB/40 Turbidity sensor range 0-40 NTU
- NIFL60 Filter with washable cartridge 60 μ fitting 8 x 12 mm hose connections
- NCA60 Filter cartridge 60 μ for NIFL60



Water Meters from WATTCCON

	<p>Cold Water Meters</p> <p>Contacting head water meters are used to control dosing systems & totalisation to counters. Use up to 30°C and pressures up to 10 bar. K = 0.25, 0.5, 1.0 or 10</p> <table border="1"> <thead> <tr> <th>Model No</th> <th>Size</th> <th></th> <th>Flow Rate</th> <th>Constant</th> </tr> </thead> <tbody> <tr> <td>CTFI 15</td> <td>1/2"</td> <td>Flow rate up to</td> <td>1.5 m³ / Hr</td> <td>K = 0.25</td> </tr> <tr> <td>CTFI 20</td> <td>3/4"</td> <td>Flow rate up to</td> <td>2.5 m³ / Hr</td> <td>K = 0.25</td> </tr> <tr> <td>CTFI 25</td> <td>1"</td> <td>Flow rate up to</td> <td>3.5 m³ / Hr</td> <td>K = 0.25</td> </tr> <tr> <td>CTFI 30</td> <td>1 1/4"</td> <td>Flow rate up to</td> <td>5 m³ / Hr</td> <td>K = 1.0</td> </tr> <tr> <td>CTFI 40</td> <td>1 1/2"</td> <td>Flow rate up to</td> <td>10 m³ / Hr</td> <td>K = 10.0</td> </tr> <tr> <td>CTFI 50</td> <td>2"</td> <td>Flow rate up to</td> <td>15 m³ / Hr</td> <td>K = 10.0</td> </tr> </tbody> </table>	Model No	Size		Flow Rate	Constant	CTFI 15	1/2"	Flow rate up to	1.5 m ³ / Hr	K = 0.25	CTFI 20	3/4"	Flow rate up to	2.5 m ³ / Hr	K = 0.25	CTFI 25	1"	Flow rate up to	3.5 m ³ / Hr	K = 0.25	CTFI 30	1 1/4"	Flow rate up to	5 m ³ / Hr	K = 1.0	CTFI 40	1 1/2"	Flow rate up to	10 m ³ / Hr	K = 10.0	CTFI 50	2"	Flow rate up to	15 m ³ / Hr	K = 10.0	Price
Model No	Size		Flow Rate	Constant																																	
CTFI 15	1/2"	Flow rate up to	1.5 m ³ / Hr	K = 0.25																																	
CTFI 20	3/4"	Flow rate up to	2.5 m ³ / Hr	K = 0.25																																	
CTFI 25	1"	Flow rate up to	3.5 m ³ / Hr	K = 0.25																																	
CTFI 30	1 1/4"	Flow rate up to	5 m ³ / Hr	K = 1.0																																	
CTFI 40	1 1/2"	Flow rate up to	10 m ³ / Hr	K = 10.0																																	
CTFI 50	2"	Flow rate up to	15 m ³ / Hr	K = 10.0																																	
	<p>Cold Water Meters Dry Runner</p> <p>Meters with dry dial (dry runner) use up to 30°C & 10 bar. K = 0.25, 0.5, 1.0 or 10</p> <table border="1"> <tbody> <tr> <td>CATFI 15</td> <td>1/2"</td> <td>Flow rate up to</td> <td>1.5 m³ / Hr</td> <td>K = 0.25</td> </tr> <tr> <td>CATFI 20</td> <td>3/4"</td> <td>Flow rate up to</td> <td>2.5 m³ / Hr</td> <td>K = 0.25</td> </tr> <tr> <td>CATFI 25</td> <td>1"</td> <td>Flow rate up to</td> <td>3.5 m³ / Hr</td> <td>K = 0.25</td> </tr> <tr> <td>CATFI 30</td> <td>1 1/4"</td> <td>Flow rate up to</td> <td>5 m³ / Hr</td> <td>K = 1.0</td> </tr> <tr> <td>CATFI 40</td> <td>1 1/2"</td> <td>Flow rate up to</td> <td>10 m³ / Hr</td> <td>K = 10.0</td> </tr> <tr> <td>CATFI 50</td> <td>2"</td> <td>Flow rate up to</td> <td>15 m³ / Hr</td> <td>K = 10.0</td> </tr> </tbody> </table>	CATFI 15	1/2"	Flow rate up to	1.5 m ³ / Hr	K = 0.25	CATFI 20	3/4"	Flow rate up to	2.5 m ³ / Hr	K = 0.25	CATFI 25	1"	Flow rate up to	3.5 m ³ / Hr	K = 0.25	CATFI 30	1 1/4"	Flow rate up to	5 m ³ / Hr	K = 1.0	CATFI 40	1 1/2"	Flow rate up to	10 m ³ / Hr	K = 10.0	CATFI 50	2"	Flow rate up to	15 m ³ / Hr	K = 10.0						
CATFI 15	1/2"	Flow rate up to	1.5 m ³ / Hr	K = 0.25																																	
CATFI 20	3/4"	Flow rate up to	2.5 m ³ / Hr	K = 0.25																																	
CATFI 25	1"	Flow rate up to	3.5 m ³ / Hr	K = 0.25																																	
CATFI 30	1 1/4"	Flow rate up to	5 m ³ / Hr	K = 1.0																																	
CATFI 40	1 1/2"	Flow rate up to	10 m ³ / Hr	K = 10.0																																	
CATFI 50	2"	Flow rate up to	15 m ³ / Hr	K = 10.0																																	
	<p>Hot Water Meters</p> <p>Hot water meters for use up to 90°C and 10 bar K = 0.25, 0.5, 1.0 or 10</p> <table border="1"> <tbody> <tr> <td>CTCI 15</td> <td>1/2"</td> <td>Flow rate up to</td> <td>1.5 m³ / Hr</td> <td>K = 0.25</td> </tr> <tr> <td>CTCI 20</td> <td>3/4"</td> <td>Flow rate up to</td> <td>2.5 m³ / Hr</td> <td>K = 0.25</td> </tr> <tr> <td>CTCI 25</td> <td>1"</td> <td>Flow rate up to</td> <td>3.5 m³ / Hr</td> <td>K = 0.25</td> </tr> <tr> <td>CTCI 30</td> <td>1 1/4"</td> <td>Flow rate up to</td> <td>5 m³ / Hr</td> <td>K = 1.0</td> </tr> <tr> <td>CTCI 40</td> <td>1 1/2"</td> <td>Flow rate up to</td> <td>10 m³ / Hr</td> <td>K = 10.0</td> </tr> <tr> <td>CTCI 50</td> <td>2"</td> <td>Flow rate up to</td> <td>15 m³ / Hr</td> <td>K = 10.0</td> </tr> </tbody> </table>	CTCI 15	1/2"	Flow rate up to	1.5 m ³ / Hr	K = 0.25	CTCI 20	3/4"	Flow rate up to	2.5 m ³ / Hr	K = 0.25	CTCI 25	1"	Flow rate up to	3.5 m ³ / Hr	K = 0.25	CTCI 30	1 1/4"	Flow rate up to	5 m ³ / Hr	K = 1.0	CTCI 40	1 1/2"	Flow rate up to	10 m ³ / Hr	K = 10.0	CTCI 50	2"	Flow rate up to	15 m ³ / Hr	K = 10.0						
CTCI 15	1/2"	Flow rate up to	1.5 m ³ / Hr	K = 0.25																																	
CTCI 20	3/4"	Flow rate up to	2.5 m ³ / Hr	K = 0.25																																	
CTCI 25	1"	Flow rate up to	3.5 m ³ / Hr	K = 0.25																																	
CTCI 30	1 1/4"	Flow rate up to	5 m ³ / Hr	K = 1.0																																	
CTCI 40	1 1/2"	Flow rate up to	10 m ³ / Hr	K = 10.0																																	
CTCI 50	2"	Flow rate up to	15 m ³ / Hr	K = 10.0																																	
	<p>Water Meters PTFE Coated</p> <p>Contacting head water meters with internal and external PTFE coating, temperature up to 90°C and pressures up to 10 bar. K = 0.25, 0.5, 1.0 or 10</p> <table border="1"> <tbody> <tr> <td>CTCIT 15</td> <td>1/2"</td> <td>Flow rate up to</td> <td>1.5 m³ / Hr</td> <td>K = 0.25</td> </tr> <tr> <td>CTCIT 20</td> <td>3/4"</td> <td>Flow rate up to</td> <td>2.5 m³ / Hr</td> <td>K = 0.25</td> </tr> <tr> <td>TCIT 25</td> <td>1"</td> <td>Flow rate up to</td> <td>3.5 m³ / Hr</td> <td>K = 0.25</td> </tr> <tr> <td>CTCIT 30</td> <td>1 1/4"</td> <td>Flow rate up to</td> <td>5 m³ / Hr</td> <td>K = 1.0</td> </tr> <tr> <td>CTCIT 40</td> <td>1 1/2"</td> <td>Flow rate up to</td> <td>10 m³ / Hr</td> <td>K = 10.0</td> </tr> </tbody> </table>	CTCIT 15	1/2"	Flow rate up to	1.5 m ³ / Hr	K = 0.25	CTCIT 20	3/4"	Flow rate up to	2.5 m ³ / Hr	K = 0.25	TCIT 25	1"	Flow rate up to	3.5 m ³ / Hr	K = 0.25	CTCIT 30	1 1/4"	Flow rate up to	5 m ³ / Hr	K = 1.0	CTCIT 40	1 1/2"	Flow rate up to	10 m ³ / Hr	K = 10.0											
CTCIT 15	1/2"	Flow rate up to	1.5 m ³ / Hr	K = 0.25																																	
CTCIT 20	3/4"	Flow rate up to	2.5 m ³ / Hr	K = 0.25																																	
TCIT 25	1"	Flow rate up to	3.5 m ³ / Hr	K = 0.25																																	
CTCIT 30	1 1/4"	Flow rate up to	5 m ³ / Hr	K = 1.0																																	
CTCIT 40	1 1/2"	Flow rate up to	10 m ³ / Hr	K = 10.0																																	
	<p>Flanged Water Meters</p> <p>Woltmann type water meters with dry dial for use up to 30°C & pressures up to 10 bar. K = 10, 100 or 1000</p> <table border="1"> <tbody> <tr> <td>CWFA 50</td> <td>2"</td> <td>Flow rate up to</td> <td>15 m³ / Hr</td> <td>K = 10.0</td> </tr> <tr> <td>CWFA 70</td> <td>2 1/2"</td> <td>Flow rate up to</td> <td>25 m³ / Hr</td> <td>K = 10.0</td> </tr> <tr> <td>CWFA 80</td> <td>3"</td> <td>Flow rate up to</td> <td>40 m³ / Hr</td> <td>K = 10.0</td> </tr> <tr> <td>CWFA 100</td> <td>4"</td> <td>Flow rate up to</td> <td>60 m³ / Hr</td> <td>K = 100.0</td> </tr> <tr> <td>CWFA 150</td> <td>6"</td> <td>Flow rate up to</td> <td>150 m³ / Hr</td> <td>K = 100.0</td> </tr> <tr> <td>CWFA 200</td> <td>8"</td> <td>Flow rate up to</td> <td>250 m³ / Hr</td> <td>K = 1000</td> </tr> </tbody> </table>	CWFA 50	2"	Flow rate up to	15 m ³ / Hr	K = 10.0	CWFA 70	2 1/2"	Flow rate up to	25 m ³ / Hr	K = 10.0	CWFA 80	3"	Flow rate up to	40 m ³ / Hr	K = 10.0	CWFA 100	4"	Flow rate up to	60 m ³ / Hr	K = 100.0	CWFA 150	6"	Flow rate up to	150 m ³ / Hr	K = 100.0	CWFA 200	8"	Flow rate up to	250 m ³ / Hr	K = 1000						
CWFA 50	2"	Flow rate up to	15 m ³ / Hr	K = 10.0																																	
CWFA 70	2 1/2"	Flow rate up to	25 m ³ / Hr	K = 10.0																																	
CWFA 80	3"	Flow rate up to	40 m ³ / Hr	K = 10.0																																	
CWFA 100	4"	Flow rate up to	60 m ³ / Hr	K = 100.0																																	
CWFA 150	6"	Flow rate up to	150 m ³ / Hr	K = 100.0																																	
CWFA 200	8"	Flow rate up to	250 m ³ / Hr	K = 1000																																	

Dosing Controllers from WATTCCON

Dose & Delay Timers



ADT-1 Timer with adjustable delay and dose times in surface mounting weatherproof enclosure with flip up lid

ADT-2 Dual timer with two adjustable delay and dose timers in surface mounting weatherproof enclosure with flip up lid.

Seven Day Timers



BT3605 Single channel seven day electronic timer for timed outputs to the nearest minute, in weatherproof corrosion resistant enclosure.

BT3607 Dual channel seven day electronic timer.

Shot Dose Timer



AST1 Shot dose timer in a weatherproof enclosure fitted with Off / Auto switch for the chemical pump. On auto the pump is operated by the start push button and runs for the duration of the timer the pump maybe stopped by switching to off

AST2 Dose delay timer and shot timer in weatherproof enclosure with Hand - off - auto switch for the chemical pump. On auto the pump is controlled by the dose - delay timer & on hand by the shot dose timer.

Microprocessor Timer



unit not available



LT4 Four channel timer which maybe programmed either as a 14 day timer, percentage timer or as an timer with external start timer with counter

Amperehours Meters & Dosing



AH515.2 Digital amperehours meter which totalises the current flowing through the electroplating bath by measuring the voltage across a suitable shunt usually 0 - 60 mV for the full load current.



AH555.2 Features a presettable count down counter of 0 - 9999 which provides an output to start a dose timer of 0 - 99 seconds duration to operate a suitable chemical dosing pump to add reagent to the plating bath to replace the chemical which has been consumed.

Residual Chlorine Controllers from WATTCCON



Potentiostatic Controller

- CL7685 Panel mounting μ P CL2 meter with two set points for on/off PFM or PWM control and a current output auto ranging 0 - 2.00 ppm & 0 - 20.0 ppm. from Potentiostatic CL2 sensor
- PEF Potentiostatic flow cell with needle valve and flow indicator.
- SZ283 Potentiostatic chlorine sensor
- W W'proof enclosure to hold 1 or 2 7600 instruments (add)

Amperometric Analogue Controller



- LCL Surface mounting chlorine controller for drinking water range 0-10.00 ppm with two control relays dose & limit timer and 0 -20 mA current output
- ECL4N Amperometric free chlorine cell (organic & inorganic) for drinking water range 0-10.00 ppm
- ECL5N Amperometric free chlorine cell for salt water range 0-10.00 ppm

Amperometric Microprocessor Controller



- LDCL Surface mounting μ P chlorine controller with menu selectable sensors up to 0 - 30.00 ppm (mg/l) Cl₂. LCD backlit display outputs on/off & proportional, dosing limit timer and 0 - 20 / 4 -20 mA current output, power supply 90 - 240 volts

LDCL requires PEF/1E sensor holder and the sensor

- PEF1/E Off line sensor holder with mini VA flow indicator, needle valve to hold sensor type ECL1, 2, 3, 8, 9, 10 or 11 & proximity switch
- SEPR. Proximity switch to suit flow cell PEF1/E

- ECL1/2 Free chlorine cell (inorganic) for sodium hypochlorite
Measuring range 0 - 2.00 mg/l
- ECL1/20 Free chlorine cell (inorganic) for sodium hypochlorite
Measuring range 0 - 20.0 mg/l

- ECL2/2 Chlorine Dioxide amperometric cell with ATC 5 - 50°C
Measuring range 0 - 2.00 mg/l
- ECL2/20 Chlorine Dioxide amperometric cell with ATC 5 - 50°C
Measuring range 0 - 20.0 mg/l

- MECL1/2 Cap and membrane for cells type ECL1/2
- ELECL1 Filling solution for amperometric cell type ECL1

- ECL3/10 Free chlorine cell (organic & inorganic) pH compensated
Measuring range 0 - 10.00 mg/l
- MECL3/10 Cap and membrane for cell type ECL3/10
- ELECL3 Filling solution for amperometric cell type ECL3/10

- ECL8/20 Total chlorine cell measuring range 0 - 20.00 mg/l
- ECL9/200 Hydrogen peroxide cell 0 - 200 or 0 - 2000 mg/l
- ECL10/5 Ozone (O₃) cell 0 - 2.00 mg/l
- ECL11/200 Peracetic acid cell 0 - 200 mg/l



Cooling Water Controllers from WATTCCON

Our range of cooling water controllers provide control and technology at a low cost. Being simple to install and operate providing precise and accurate control of your process resulting in lower operating costs.



Flow Proportional Feed & Bleed with Dual Biocide Dosing

LT4 New microprocessor based controller with up to four relay outputs which maybe user configured as 7/28 day real time clocks, dose & delay timers or counter timers. Allowing dual 28 day biocide dosing and flow proportional bleed and inhibitor dosing.



TDS Bleed

LCD-B Cooling Water TDS Controller range 0 - 2000 μ S or 0 - 20.00 mS with 2 control relays and a 0 - 20 mA current output supply 230 VAC Supplied with Conductivity cell P/No FL310



FL310T Replacement conductivity cell with QR Fitting & ATC



Redox / ORP Control

ARB-1 Cooling Water Redox / ORP Controller range 0 - 1000 mV with 2 control relays and a 0 - 20 mA current output supply 230 VAC Supplied with Redox electrode system P/No RES1-QR



9065-10B Replacement Redox electrode glass bodied with 3 metre cable

TDS Bleed, Feed, Biocide & ORP Control



ACW 4 Microprocessor controlled Cooling Water Controller with Redox controlled oxidising biocide, seven day timer controlled non oxidising biocide, flow proportional inhibitor dosing, and conductivity (TDS) controlled bleed range 0-20.00mS Push button for manual output of 5 mins with revert to auto after the timer has elapsed. In a weatherproof enclosure. Including :-



Conductivity cell and redox electrode with PVC. Tees

Cell fitted with 10 metre length LMK2 connecting cable add. pH-Ex cable LMK1 10 m length with wpoof connectors add

Additional Items



CTFI 20 Water meter 3/4" BSP Flow rate up to 2.5 m³ / Hr K = 0.25
CTFI 25 Water meter 1" BSP Flow rate up to 3.5 m³ / Hr K = 0.25
CTFI 40 Water meter 1 1/2" BSP Flow rate up to 10 m³ / Hr K = 10.0



HCO 20 - 01V Dosing pump 0 - 1 l/Hr against 20 bar 240 VAC
HCO 10 - 04V Dosing pump 0 - 4 l/Hr against 10 bar 240 VAC
HCO 04 - 08V Dosing pump 0 - 8 l/Hr against 4.0 bar 240 VAC



BSV 050 00 Brass solenoid valve 1/2" BSP with IP65 240 VAC coil
BSV 075 00 Brass solenoid valve 3/4" BSP with IP65 240 VAC coil

Cooling Water Back Plate Systems from WATTCCON

Backplate Systems



Back plate systems are ready wired and assembled cooling water control systems. Comprising of the controller, a PVC manifold with valves and sensors etc. Bleed valve and dosing pumps as required by the control system. All ready plumbed and wired for easy and quick installation on site. To be connected on the flow side of the circulating pump and piped to the tower sump.

Several systems are listed below

- BT3605-BPS** Back plate system comprising of the Model BT3605 single biocide timer and FCO 05 - 05 dosing pump.
- BT3607-BPS** Back plate system comprising of the Model BT3607 dual biocide timer and 2 FCO 05 - 05 dosing pumps.
- ACW1-BPS** Back plate system comprising of the Model ACW1 bleed & feed controller with FCO 05 - 05 dosing pump and bleed valve
Additional equipment required Water meter 3/4".
- C3645-BPS** Back plate systems comprising of Conductivity (TDS) controller with flow line conductivity cell and BSV 075 - 00 3/4" solenoid valve
- ACW2-BPS** Back plate systems comprising of Model ACW2 dual biocide, feed & bleed controller with 3 FCO 05 - 05 dosing pumps and 3/4" solenoid valve
Additional equipment required Water meter 3/4".
- ACW3-BPS** Back plate systems comprising of Model ACW3 controller dual biocide, flow proportional feed & TDS bleed with 3 FCO 05 - 05 dosing pumps, FL310 cell and 3/4" solenoid valve.
Additional equipment required Water meter 3/4".
- ACW4-BPS** Back plate systems comprising of Model ACW4 controller
Single biocide, Redox controlled Bromine dosing, flow proportional feed & TDS bleed with 2 FCO 05 - 05 dosing pumps, FL310 cell RES1-QR ORP electrode and 2 x 3/4" solenoid valves.
Additional equipment required Water meter 3/4"
Bromine tablet holders to be selected from tablet brominators
- ACW4-BG-BPS** Back plate systems comprising of Model ACW4 controller
Single biocide, Redox controlled Bromine dosing, flow proportional feed & TDS bleed with 4 FCO 05 - 05 dosing pumps, FL310 cell RES1-QR ORP electrode and 2 x 3/4" solenoid valves.
Additional equipment required Water meter 3/4"

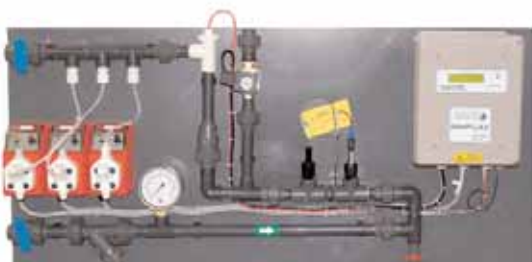

Boiler & Hot Water Controllers from WATTCCON



Boiler Blowdown Timed Control.

ABD-T Boiler blowdown timer with adjustable delay and blowdown timers in a surface mounting enclosure supplied with

Blowdown valve 1/2" High temp solenoid 1 - 8 bar 170 °C
Inline strainer 1/2" B.S.P.



Boiler Blowdown TDS Control.

MB2 The MB2 is a Boiler blowdown controller of the timed sample monitoring system with adjustable conductivity (TDS) set-point. Features flow proportional dosing from a hot water meter in the boiler feed water lined. Mians supply 240 volt AC. Supplied with

Inline strainer 1/2" B.S.P. Blowdown valve 1/2" ball valve with electric 10 bar & 200c. IN4 10 HT High temperature insertion conductivity cell. Regulating valvel 1/2" BSP.



Condensate Control

C3645 -CC-K Conductivity controller with digital display adjustable set point range 0 - 200µS. Supplied in surface mounting weatherproof corrosion resistant enclosure with flip up lid supplied with

High temp conductivity cell.
5 metres LMK2 Connecting cable
1" BSP pneumatic dump valve with 1/4" BSP Pilot valve



Sample Coolers

SC-LP-FC Sample cooler with mild steel body, wall mounting brackets with low pressure fixed copper coil and brass regulating valve. Shell pressure 150 P.S.I. Coil pressure 350 P.S.I.

SC-HP-FC Sample cooler with steel body, wall mounting brackets with high pressure fixed stainless coil and gunmetal regulating valve. Shell pressure 150 P.S.I. Coil pressure 1000 P.S.I.

Prices exclude regulating valves and fittings which are available to suit please contact the sale office with your requirements.



Chemical Dosing Pots.

Chemical Dosing Pots manufactured from seam welded tube, with inlet, outlet and air purge valves Max pressure 150 PSI.



CDP 05 5 litres capacity Overall size 565 x 220 mm

CDP 10 10 litres capacity Overall size 885 x 220 mm



CDP 15 15 litres capacity Overall size 755 x 300 mm







Red Electronic Metering Pumps from WATTCCON

	<p>F Series</p> <p>FCO Dosing pumps have manual output control of the stroke frequency</p> <table style="width: 100%; border-collapse: collapse;"> <thead> <tr> <th style="text-align: left;">Model No</th> <th style="text-align: left;">Output L/Hr.</th> <th style="text-align: left;">Pressure Bar</th> <th style="text-align: left;">Hose Size</th> <th style="text-align: left;">Pump Head</th> </tr> </thead> <tbody> <tr> <td>FCO 12 - 015</td> <td>0 - 1.5</td> <td>12.0</td> <td>6.0 mm OD</td> <td>PCS</td> </tr> <tr> <td>FCO 07 - 03</td> <td>0 - 3.0</td> <td>7.0</td> <td>6.0 mm OD</td> <td>PCS</td> </tr> <tr> <td>FCO 05 - 05</td> <td>0 - 5.0</td> <td>5.0</td> <td>6.0 mm OD</td> <td>PCS</td> </tr> </tbody> </table> <p>FPV Pumps have manual or external control of stroke frequency & low level float switch cutout.</p> <table style="width: 100%; border-collapse: collapse;"> <thead> <tr> <th style="text-align: left;">Model No</th> <th style="text-align: left;">Output L/Hr.</th> <th style="text-align: left;">Pressure Bar</th> <th style="text-align: left;">Hose Size</th> <th style="text-align: left;">Pump Head</th> </tr> </thead> <tbody> <tr> <td>FPV 12 - 015</td> <td>0 - 1.5</td> <td>12.0</td> <td>6.0 mm OD</td> <td>PCS</td> </tr> <tr> <td>FPV 07 - 03</td> <td>0 - 3.0</td> <td>7.0</td> <td>6.0 mm OD</td> <td>PCS</td> </tr> <tr> <td>FPV 05 - 05</td> <td>0 - 5.0</td> <td>5.0</td> <td>6.0 mm OD</td> <td>PCS</td> </tr> </tbody> </table> <p>-PVDF/BV fitted with PVDF inlet and discharge ball valves and viton seals add -SS/BV fitted with stainless steel inlet and discharge ball valves and viton seals add -PVDF Pump fitted with PVDF liquid end and viton seals add</p>	Model No	Output L/Hr.	Pressure Bar	Hose Size	Pump Head	FCO 12 - 015	0 - 1.5	12.0	6.0 mm OD	PCS	FCO 07 - 03	0 - 3.0	7.0	6.0 mm OD	PCS	FCO 05 - 05	0 - 5.0	5.0	6.0 mm OD	PCS	Model No	Output L/Hr.	Pressure Bar	Hose Size	Pump Head	FPV 12 - 015	0 - 1.5	12.0	6.0 mm OD	PCS	FPV 07 - 03	0 - 3.0	7.0	6.0 mm OD	PCS	FPV 05 - 05	0 - 5.0	5.0	6.0 mm OD	PCS										
Model No	Output L/Hr.	Pressure Bar	Hose Size	Pump Head																																															
FCO 12 - 015	0 - 1.5	12.0	6.0 mm OD	PCS																																															
FCO 07 - 03	0 - 3.0	7.0	6.0 mm OD	PCS																																															
FCO 05 - 05	0 - 5.0	5.0	6.0 mm OD	PCS																																															
Model No	Output L/Hr.	Pressure Bar	Hose Size	Pump Head																																															
FPV 12 - 015	0 - 1.5	12.0	6.0 mm OD	PCS																																															
FPV 07 - 03	0 - 3.0	7.0	6.0 mm OD	PCS																																															
FPV 05 - 05	0 - 5.0	5.0	6.0 mm OD	PCS																																															
	<p>V Series</p> <p>VCO Dosing pumps have manual output control of the stroke frequency</p> <table style="width: 100%; border-collapse: collapse;"> <thead> <tr> <th style="text-align: left;">Model No</th> <th style="text-align: left;">Output L/Hr.</th> <th style="text-align: left;">Pressure Bar</th> <th style="text-align: left;">Hose Size</th> <th style="text-align: left;">Pump Head</th> </tr> </thead> <tbody> <tr> <td>VCO 20 - 01</td> <td>0 - 1.0</td> <td>20.0</td> <td>8.0 mm OD</td> <td>PCS</td> </tr> <tr> <td>VCO 10 - 04</td> <td>0 - 4.0</td> <td>10.0</td> <td>6.0 mm OD</td> <td>PCS</td> </tr> <tr> <td>VCO 04 - 08</td> <td>0 - 8.0</td> <td>8.0</td> <td>6.0 mm OD</td> <td>PCS</td> </tr> <tr> <td>VCO 10 - 10</td> <td>0 -10.0</td> <td>10.0</td> <td>6.0 mm OD</td> <td>PCS</td> </tr> </tbody> </table> <p>VMS Microprocessor multifunction pump with constant multiply divide ppm batch volt and current input all user selectable via the key pad with low level control.</p> <table style="width: 100%; border-collapse: collapse;"> <thead> <tr> <th style="text-align: left;">Model No</th> <th style="text-align: left;">Output L/Hr.</th> <th style="text-align: left;">Pressure Bar</th> <th style="text-align: left;">Hose Size</th> <th style="text-align: left;">Pump Head</th> </tr> </thead> <tbody> <tr> <td>VMS 20 - 01</td> <td>0 - 1.0</td> <td>20.0</td> <td>8.0 mm OD</td> <td>PCS</td> </tr> <tr> <td>VMS 10 - 04</td> <td>0 - 4.0</td> <td>10.0</td> <td>6.0 mm OD</td> <td>PCS</td> </tr> <tr> <td>VMS 04 - 08</td> <td>0 - 8.0</td> <td>8.0</td> <td>6.0 mm OD</td> <td>PCS</td> </tr> <tr> <td>VMS 10 - 10</td> <td>0 -10.0</td> <td>10.0</td> <td>6.0 mm OD</td> <td>PCS</td> </tr> </tbody> </table> <p>-PVDF Pump fitted with PVDF hoses</p>	Model No	Output L/Hr.	Pressure Bar	Hose Size	Pump Head	VCO 20 - 01	0 - 1.0	20.0	8.0 mm OD	PCS	VCO 10 - 04	0 - 4.0	10.0	6.0 mm OD	PCS	VCO 04 - 08	0 - 8.0	8.0	6.0 mm OD	PCS	VCO 10 - 10	0 -10.0	10.0	6.0 mm OD	PCS	Model No	Output L/Hr.	Pressure Bar	Hose Size	Pump Head	VMS 20 - 01	0 - 1.0	20.0	8.0 mm OD	PCS	VMS 10 - 04	0 - 4.0	10.0	6.0 mm OD	PCS	VMS 04 - 08	0 - 8.0	8.0	6.0 mm OD	PCS	VMS 10 - 10	0 -10.0	10.0	6.0 mm OD	PCS
Model No	Output L/Hr.	Pressure Bar	Hose Size	Pump Head																																															
VCO 20 - 01	0 - 1.0	20.0	8.0 mm OD	PCS																																															
VCO 10 - 04	0 - 4.0	10.0	6.0 mm OD	PCS																																															
VCO 04 - 08	0 - 8.0	8.0	6.0 mm OD	PCS																																															
VCO 10 - 10	0 -10.0	10.0	6.0 mm OD	PCS																																															
Model No	Output L/Hr.	Pressure Bar	Hose Size	Pump Head																																															
VMS 20 - 01	0 - 1.0	20.0	8.0 mm OD	PCS																																															
VMS 10 - 04	0 - 4.0	10.0	6.0 mm OD	PCS																																															
VMS 04 - 08	0 - 8.0	8.0	6.0 mm OD	PCS																																															
VMS 10 - 10	0 -10.0	10.0	6.0 mm OD	PCS																																															
	<p>GCO Series</p> <p>GCO Dosing pumps with manually adjustable outputs over the dosing range.</p> <table style="width: 100%; border-collapse: collapse;"> <thead> <tr> <th style="text-align: left;">Model No</th> <th style="text-align: left;">Output L/Hr.</th> <th style="text-align: left;">Pressure Bar</th> <th style="text-align: left;">Hose Size</th> <th style="text-align: left;">Pump Head</th> </tr> </thead> <tbody> <tr> <td>0</td> <td></td> <td></td> <td></td> <td></td> </tr> <tr> <td>GCO 03 - 30</td> <td>0 - 30.0</td> <td>3.0</td> <td>12.0 mm OD</td> <td>E</td> </tr> <tr> <td>GCO 01 - 50</td> <td>0 - 50.0</td> <td>1.0</td> <td>12.0 mm OD</td> <td>E</td> </tr> <tr> <td>GCO 00 - 100</td> <td>0 - 100.0</td> <td>0.0</td> <td>12.0 mm OD</td> <td>F</td> </tr> </tbody> </table> <p>-PVDF Pump fitted with PVDF liquid end and viton seals up to 30 l/h (add) -PVDF Pump fitted with PVDF liquid end and viton seals up to 100 l/h (add) GPV series pumps with external pacing and low level input (add)</p>	Model No	Output L/Hr.	Pressure Bar	Hose Size	Pump Head	0					GCO 03 - 30	0 - 30.0	3.0	12.0 mm OD	E	GCO 01 - 50	0 - 50.0	1.0	12.0 mm OD	E	GCO 00 - 100	0 - 100.0	0.0	12.0 mm OD	F																									
Model No	Output L/Hr.	Pressure Bar	Hose Size	Pump Head																																															
0																																																			
GCO 03 - 30	0 - 30.0	3.0	12.0 mm OD	E																																															
GCO 01 - 50	0 - 50.0	1.0	12.0 mm OD	E																																															
GCO 00 - 100	0 - 100.0	0.0	12.0 mm OD	F																																															





Red Electronic Metering Pumps from WATTCCON

	KCO Series																																																																																
	<p>KCO Dosing pumps with manually adjustable frequency and stroke length.</p> <table border="1"> <thead> <tr> <th>Model No</th> <th>Output L/Hr.</th> <th>Pressure Bar</th> <th>Hose Size</th> <th>Pump Head</th> </tr> </thead> <tbody> <tr> <td>KCO 20 - 01</td> <td>0 - 1.0</td> <td>20.0</td> <td>8.0 mm OD</td> <td>A</td> </tr> <tr> <td>KCO 10 - 04</td> <td>0 - 4.0</td> <td>10.0</td> <td>6.0 mm OD</td> <td>B</td> </tr> <tr> <td>KCO 04 - 08</td> <td>0 - 8.0</td> <td>4.0</td> <td>6.0 mm OD</td> <td>B</td> </tr> <tr> <td>KCO 02 - 16</td> <td>0 - 16.0</td> <td>2.0</td> <td>8.0 mm OD</td> <td>G</td> </tr> </tbody> </table>	Model No	Output L/Hr.	Pressure Bar	Hose Size	Pump Head	KCO 20 - 01	0 - 1.0	20.0	8.0 mm OD	A	KCO 10 - 04	0 - 4.0	10.0	6.0 mm OD	B	KCO 04 - 08	0 - 8.0	4.0	6.0 mm OD	B	KCO 02 - 16	0 - 16.0	2.0	8.0 mm OD	G																																																							
Model No	Output L/Hr.	Pressure Bar	Hose Size	Pump Head																																																																													
KCO 20 - 01	0 - 1.0	20.0	8.0 mm OD	A																																																																													
KCO 10 - 04	0 - 4.0	10.0	6.0 mm OD	B																																																																													
KCO 04 - 08	0 - 8.0	4.0	6.0 mm OD	B																																																																													
KCO 02 - 16	0 - 16.0	2.0	8.0 mm OD	G																																																																													
	KPVM Series																																																																																
	<p>KPVM Dosing Pumps with external control from volt free contacts which maybe multiplied or divided to suit the water meter K factor also fitted low level control.</p> <table border="1"> <thead> <tr> <th>Model No</th> <th>Output L/Hr.</th> <th>Pressure Bar</th> <th>Hose Size</th> <th>Pump Head</th> </tr> </thead> <tbody> <tr> <td>KPVM 20 - 01</td> <td>0 - 1.0</td> <td>20.0</td> <td>6.0 mm OD</td> <td>A</td> </tr> <tr> <td>KPVM 10 - 04</td> <td>0 - 4.0</td> <td>10.0</td> <td>6.0 mm OD</td> <td>B</td> </tr> <tr> <td>KPVM 04 - 08</td> <td>0 - 8.0</td> <td>4.0</td> <td>6.0 mm OD</td> <td>B</td> </tr> <tr> <td>KPVM 02 - 16</td> <td>0 - 16.0</td> <td>2.0</td> <td>8.0 mm OD</td> <td>G</td> </tr> </tbody> </table> <p>-PVDF Pump fitted with PVDF hoses 0406 add -SS Pump fitted with Stainless Steel head no accessories or hose add</p>	Model No	Output L/Hr.	Pressure Bar	Hose Size	Pump Head	KPVM 20 - 01	0 - 1.0	20.0	6.0 mm OD	A	KPVM 10 - 04	0 - 4.0	10.0	6.0 mm OD	B	KPVM 04 - 08	0 - 8.0	4.0	6.0 mm OD	B	KPVM 02 - 16	0 - 16.0	2.0	8.0 mm OD	G																																																							
Model No	Output L/Hr.	Pressure Bar	Hose Size	Pump Head																																																																													
KPVM 20 - 01	0 - 1.0	20.0	6.0 mm OD	A																																																																													
KPVM 10 - 04	0 - 4.0	10.0	6.0 mm OD	B																																																																													
KPVM 04 - 08	0 - 8.0	4.0	6.0 mm OD	B																																																																													
KPVM 02 - 16	0 - 16.0	2.0	8.0 mm OD	G																																																																													
	CMS PV Series																																																																																
	<p>CMS Dosing pumps have the same functionality as the HPVM series. Standard wetted parts are polypropylene head & valves PTFE diaphragm & ceramic valves with either Viton or EPDM seals.</p> <table border="1"> <thead> <tr> <th>Model No</th> <th>Output L/Hr.</th> <th>Pressure Bar</th> <th>Hose Size</th> <th>Pump Head</th> </tr> </thead> <tbody> <tr> <td>CMS-PV 25 - 05</td> <td>0 - 5.0</td> <td>25.0</td> <td>8.0 mm OD</td> <td>B</td> </tr> <tr> <td>CMS-PV 15 - 10</td> <td>0 - 10.0</td> <td>15.0</td> <td>8.0 mm OD</td> <td>C</td> </tr> <tr> <td>CMS-PV 07 - 20</td> <td>0 - 20.0</td> <td>7.0</td> <td>8.0 mm OD</td> <td>D</td> </tr> <tr> <td>CMS-PV 03 - 40</td> <td>0 - 40.0</td> <td>3.0</td> <td>12.0 mm OD</td> <td>E</td> </tr> <tr> <td>CMS -PV 02 - 60</td> <td>0 - 60.0</td> <td>2.0</td> <td>12.0 mm OD</td> <td>F</td> </tr> </tbody> </table> <p>Optional wetted parts are PVDF head and valves PTFE diaphragm and valves Viton seals</p> <table border="1"> <tbody> <tr> <td>CMS-PV 25 - 05 - PVDF</td> <td>0 - 5.0</td> <td>25.0</td> <td>8.0 mm OD</td> <td>B</td> </tr> <tr> <td>CMS-PV 15 - 10 - PVDF</td> <td>0 - 10.0</td> <td>15.0</td> <td>8.0 mm OD</td> <td>C</td> </tr> <tr> <td>CMS-PV 07 - 20 - PVDF</td> <td>0 - 20.0</td> <td>7.0</td> <td>8.0 mm OD</td> <td>D</td> </tr> <tr> <td>CMS-PV 03 - 40 - PVDF</td> <td>0 - 40.0</td> <td>3.0</td> <td>10.0 mm OD</td> <td>E</td> </tr> <tr> <td>CMS-PV 02 - 60 - PVDF</td> <td>0 - 60.0</td> <td>2.0</td> <td>10.0 mm OD</td> <td>F</td> </tr> </tbody> </table> <p>Optional wetted parts are 316 SS head and valves PTFE diaphragm and Viton or EPDM seals</p> <table border="1"> <tbody> <tr> <td>CMS-PV 25 - 05 - SS</td> <td>0 - 5.0</td> <td>25.0</td> <td>BSP Male Thread</td> <td>B</td> </tr> <tr> <td>CMS-PV 15 - 10 - SS</td> <td>0 - 10.0</td> <td>15.0</td> <td>BSP Male Thread</td> <td>C</td> </tr> <tr> <td>CMS-PV 07 - 20 - SS</td> <td>0 - 20.0</td> <td>7.0</td> <td>BSP Male Thread</td> <td>D</td> </tr> <tr> <td>CMS-PV 03 - 40 - SS</td> <td>0 - 40.0</td> <td>3.0</td> <td>BSP Male Thread</td> <td>E</td> </tr> <tr> <td>CMS-PV 02 - 60 - SS</td> <td>0 - 60.0</td> <td>2.0</td> <td>BSP Male Thread</td> <td>F</td> </tr> </tbody> </table>	Model No	Output L/Hr.	Pressure Bar	Hose Size	Pump Head	CMS-PV 25 - 05	0 - 5.0	25.0	8.0 mm OD	B	CMS-PV 15 - 10	0 - 10.0	15.0	8.0 mm OD	C	CMS-PV 07 - 20	0 - 20.0	7.0	8.0 mm OD	D	CMS-PV 03 - 40	0 - 40.0	3.0	12.0 mm OD	E	CMS -PV 02 - 60	0 - 60.0	2.0	12.0 mm OD	F	CMS-PV 25 - 05 - PVDF	0 - 5.0	25.0	8.0 mm OD	B	CMS-PV 15 - 10 - PVDF	0 - 10.0	15.0	8.0 mm OD	C	CMS-PV 07 - 20 - PVDF	0 - 20.0	7.0	8.0 mm OD	D	CMS-PV 03 - 40 - PVDF	0 - 40.0	3.0	10.0 mm OD	E	CMS-PV 02 - 60 - PVDF	0 - 60.0	2.0	10.0 mm OD	F	CMS-PV 25 - 05 - SS	0 - 5.0	25.0	BSP Male Thread	B	CMS-PV 15 - 10 - SS	0 - 10.0	15.0	BSP Male Thread	C	CMS-PV 07 - 20 - SS	0 - 20.0	7.0	BSP Male Thread	D	CMS-PV 03 - 40 - SS	0 - 40.0	3.0	BSP Male Thread	E	CMS-PV 02 - 60 - SS	0 - 60.0	2.0	BSP Male Thread	F
Model No	Output L/Hr.	Pressure Bar	Hose Size	Pump Head																																																																													
CMS-PV 25 - 05	0 - 5.0	25.0	8.0 mm OD	B																																																																													
CMS-PV 15 - 10	0 - 10.0	15.0	8.0 mm OD	C																																																																													
CMS-PV 07 - 20	0 - 20.0	7.0	8.0 mm OD	D																																																																													
CMS-PV 03 - 40	0 - 40.0	3.0	12.0 mm OD	E																																																																													
CMS -PV 02 - 60	0 - 60.0	2.0	12.0 mm OD	F																																																																													
CMS-PV 25 - 05 - PVDF	0 - 5.0	25.0	8.0 mm OD	B																																																																													
CMS-PV 15 - 10 - PVDF	0 - 10.0	15.0	8.0 mm OD	C																																																																													
CMS-PV 07 - 20 - PVDF	0 - 20.0	7.0	8.0 mm OD	D																																																																													
CMS-PV 03 - 40 - PVDF	0 - 40.0	3.0	10.0 mm OD	E																																																																													
CMS-PV 02 - 60 - PVDF	0 - 60.0	2.0	10.0 mm OD	F																																																																													
CMS-PV 25 - 05 - SS	0 - 5.0	25.0	BSP Male Thread	B																																																																													
CMS-PV 15 - 10 - SS	0 - 10.0	15.0	BSP Male Thread	C																																																																													
CMS-PV 07 - 20 - SS	0 - 20.0	7.0	BSP Male Thread	D																																																																													
CMS-PV 03 - 40 - SS	0 - 40.0	3.0	BSP Male Thread	E																																																																													
CMS-PV 02 - 60 - SS	0 - 60.0	2.0	BSP Male Thread	F																																																																													

Red Electronic Metering Pumps from WATTCCON

	<p>Air Operated Dosing pumps</p> <p>Standard dosing pumps fitted with air solenoid and air transformer so there are no electrical components in the dosing pump if the air supply is fitted with an approved solenoid valve these pumps maybe suitable for use in hazardous areas subject to local approval.</p> <table style="width: 100%; border-collapse: collapse;"> <thead> <tr> <th style="text-align: left;">Model No</th> <th style="text-align: left;">Output L/Hr.</th> <th style="text-align: left;">Pressure Bar</th> <th style="text-align: left;">Hose Size</th> </tr> </thead> <tbody> <tr> <td>FACEX 20 - 1</td> <td>0 - 1.0</td> <td>20.0</td> <td>8.0 mm OD</td> </tr> <tr> <td>FACEX 10 - 5</td> <td>0 - 5.0</td> <td>10.0</td> <td>6.0 mm OD</td> </tr> <tr> <td>GACEX 10 - 50</td> <td>0 - 50.0</td> <td>10.0</td> <td>12.0 mm OD</td> </tr> <tr> <td>GACEX 05 - 140</td> <td>0 - 140.0</td> <td>5.0</td> <td>16.0 mm OD</td> </tr> <tr> <td>GACEX 00 - 180</td> <td>0 - 180.0</td> <td>00.0</td> <td>16.0 mm OD</td> </tr> </tbody> </table> <p>PVDF heads as F or G Series prices</p>	Model No	Output L/Hr.	Pressure Bar	Hose Size	FACEX 20 - 1	0 - 1.0	20.0	8.0 mm OD	FACEX 10 - 5	0 - 5.0	10.0	6.0 mm OD	GACEX 10 - 50	0 - 50.0	10.0	12.0 mm OD	GACEX 05 - 140	0 - 140.0	5.0	16.0 mm OD	GACEX 00 - 180	0 - 180.0	00.0	16.0 mm OD		
Model No	Output L/Hr.	Pressure Bar	Hose Size																								
FACEX 20 - 1	0 - 1.0	20.0	8.0 mm OD																								
FACEX 10 - 5	0 - 5.0	10.0	6.0 mm OD																								
GACEX 10 - 50	0 - 50.0	10.0	12.0 mm OD																								
GACEX 05 - 140	0 - 140.0	5.0	16.0 mm OD																								
GACEX 00 - 180	0 - 180.0	00.0	16.0 mm OD																								
	<p>GCO Dosing pumps no longer available.</p>																										
	<p>CMS Series High Viscosity Dosing pumps</p> <p>CMS Dosing pumps have manual control of stroke length & frequency or external control of frequency by volt free contacts in water meter or analogue tof current convertor.</p> <table style="width: 100%; border-collapse: collapse;"> <thead> <tr> <th style="text-align: left;">Model No</th> <th style="text-align: left;">Output L/Hr.</th> <th style="text-align: left;">Pressure Bar</th> <th style="text-align: left;">Hose Size Suction & Del</th> </tr> </thead> <tbody> <tr> <td>CMS-PV 08 - 02</td> <td>0 - 2.0</td> <td>8.0</td> <td>20 x 27 mm & 16 x 22 mm</td> </tr> <tr> <td>CMS-PV 06 - 04</td> <td>0 - 4.0</td> <td>6.0</td> <td>20 x 27 mm & 16 x 22 mm</td> </tr> <tr> <td>CMS-PV 04 - 10</td> <td>0 - 10.0</td> <td>4.0</td> <td>20 x 27 mm & 16 x 22 mm</td> </tr> <tr> <td>CMS-PV 02 - 25</td> <td>0 - 25.0</td> <td>2.0</td> <td>20 x 27 mm & 16 x 22 mm</td> </tr> <tr> <td>CMS-PV 01 - 40</td> <td>0 - 40.0</td> <td>1.0</td> <td>20 x 27 mm & 16 x 22 mm</td> </tr> </tbody> </table>	Model No	Output L/Hr.	Pressure Bar	Hose Size Suction & Del	CMS-PV 08 - 02	0 - 2.0	8.0	20 x 27 mm & 16 x 22 mm	CMS-PV 06 - 04	0 - 4.0	6.0	20 x 27 mm & 16 x 22 mm	CMS-PV 04 - 10	0 - 10.0	4.0	20 x 27 mm & 16 x 22 mm	CMS-PV 02 - 25	0 - 25.0	2.0	20 x 27 mm & 16 x 22 mm	CMS-PV 01 - 40	0 - 40.0	1.0	20 x 27 mm & 16 x 22 mm		
Model No	Output L/Hr.	Pressure Bar	Hose Size Suction & Del																								
CMS-PV 08 - 02	0 - 2.0	8.0	20 x 27 mm & 16 x 22 mm																								
CMS-PV 06 - 04	0 - 4.0	6.0	20 x 27 mm & 16 x 22 mm																								
CMS-PV 04 - 10	0 - 10.0	4.0	20 x 27 mm & 16 x 22 mm																								
CMS-PV 02 - 25	0 - 25.0	2.0	20 x 27 mm & 16 x 22 mm																								
CMS-PV 01 - 40	0 - 40.0	1.0	20 x 27 mm & 16 x 22 mm																								
	<p>WT4 Dual Headed Dosing pumps</p> <p>WT4 Dosing pumps have 2 PVDF heads with microprocessor controls featuring Flow proportional dosing from external contacts, counter timer, dose and delay timer or 7/28 day real time clock</p> <table style="width: 100%; border-collapse: collapse;"> <thead> <tr> <th style="text-align: left;">Model No</th> <th style="text-align: left;">Output L/Hr.</th> <th style="text-align: left;">Pressure Bar</th> <th style="text-align: left;">Hose Size</th> <th style="text-align: left;">Pump Head</th> </tr> </thead> <tbody> <tr> <td>WT4 20 - 01</td> <td>0 - 1.0</td> <td>20.0</td> <td>8.0 mm OD</td> <td>PCS</td> </tr> <tr> <td>WT4 10 - 04</td> <td>0 - 4.0</td> <td>10.0</td> <td>6.0 mm OD</td> <td>PCS</td> </tr> <tr> <td>WT4 04 - 08</td> <td>0 - 8.0</td> <td>8.0</td> <td>6.0 mm OD</td> <td>PCS</td> </tr> <tr> <td>WT4 10 - 10</td> <td>0 -10.0</td> <td>10.0</td> <td>6.0 mm OD</td> <td>PCS</td> </tr> </tbody> </table>	Model No	Output L/Hr.	Pressure Bar	Hose Size	Pump Head	WT4 20 - 01	0 - 1.0	20.0	8.0 mm OD	PCS	WT4 10 - 04	0 - 4.0	10.0	6.0 mm OD	PCS	WT4 04 - 08	0 - 8.0	8.0	6.0 mm OD	PCS	WT4 10 - 10	0 -10.0	10.0	6.0 mm OD	PCS	
Model No	Output L/Hr.	Pressure Bar	Hose Size	Pump Head																							
WT4 20 - 01	0 - 1.0	20.0	8.0 mm OD	PCS																							
WT4 10 - 04	0 - 4.0	10.0	6.0 mm OD	PCS																							
WT4 04 - 08	0 - 8.0	8.0	6.0 mm OD	PCS																							
WT4 10 - 10	0 -10.0	10.0	6.0 mm OD	PCS																							

Metering Pumps Accessories from WATTCCON

	<p>Dosing Hose.</p> <p>4/6 LPE 4 x 6 mm L.D.P.E. Dosing tubing 30 metre coil 4/8LPE. 4 x 8 mm L.D.P.E. Dosing tubing 30 metre coil 6/8 LPE. 6 x 8 mm L.D.P.E. Dosing tubing 30 metre coil 08/12 LPE 8 x 12 mm L.D.P.E. Dosing tubing 30 metre coil</p> <p>4/6 PTFE 4 x 6 mm H.D.P.E. Dosing tubing 30 metre coil 4/8 PTFE. 4 x 8 mm H.D.P.E. Dosing tubing 30 metre coi 6/8 PTFE. 6 x 8 mm H.D.P.E. Dosing tubing 30 metre coil 08/12 PTFE 8 x 12 mm H.D.P.E. Dosing tubing 30 metre coil</p> <p>4/6 PVDF. 4 x 6 mm PVDF. Dosing tubing 30 metre coil 6/8 PVDF 6 x 8 mm PVDF. Dosing tubing 30 metre coil 8/10 PVDF 8 x 10 mm PVDF. Dosing tubing 30 metre coil</p> <p>Dosing hose must be protected from frost and direct sunlight. Ensure hose is compatible with the chemical you are dosing. <i>We recommend all dosing hose is installed inside a secondary pipe or hose for mechanical protection against damage.</i></p>	
	<p>Diaphragm Valves</p> <p>Multifunction valve (pressure, safety, anti-syphon and bleed) 1/2" connections for different hoses. Pressure range 1 - 5 bar, safety valve range 1 - 18 bar. Discharge connection 3/8" for 4x6 mm hose to be piped to feed vessel</p> <p>VMF/V Multifunction valve polypropylene body and Viton seals VMF/D Multifunction valve polypropylene body and EPDM seals</p> <p>VMFK/V Multifunction valve PVDF body and Viton seals VMFK/D Multifunction valve PVDF body and EPDM seals</p>	
	<p>Injection Quills & Suction Lances</p> <p>LASP Suction lance, foot valve & level control 3/8" for 4 x 6 mm tube. LASP1 Suction lance, foot valve & level control 1/2" for 8 x 12 mm tube. LIN-V (D) Injection quill with NRV in PVC with Viton / EPDM "O" rings LINR-V (D) Injection quill with NRV and ball valve in PVC with Viton / EPDM "O" rings</p> <p>SS-INJ - Q Injection quill with ball valve in 3/8 " 316 stainless steel up to 500mm long</p>	
	<p>Flow Sensors.</p> <p>Flow sensor with adjustable sensitivity to provide a N/C contact, max temp 45°C</p> <p>SEFL-V-23-001-2-SB 3/8" BSP connection for 4 x 6 LDPE tube in PVDF with Viton seals SEFL-D-23-001-2-SB 3/8" BSP connection for 4 x 6 LDPE tube in PVDF with EPDM seals</p> <p>SEFL-V-24-001-2-SB 3/8" BSP connection for 6 x 8 LDPE tube in PVDF with Viton seals SEFL-D-24-001-2-SB 3/8" BSP connection for 6 x8 LDPE tube in PVDF with EPDM seals</p>	

F, H, V and G Series Pump Spares from WATTCCON

Pump Spares

B

Remake it kits which contain all the components to remake the liquid end of the pump including head, diaphragm, suction and delivery valves. For any items not listed please call our sales office.

F Series Pump Spares



F-RMK-PCS-E	Remake kit (PP+EPDM+CE) Pump F 12-015, 07-03, 05-05 & 05-07
F-RMK-PCS-V	Remake kit (PP+Viton+CE) Pump F 12-015, 07-03, 05-05 & 05-07
F-RMK-PCS-PVDF	Remake kit (PVDF+Viton+PTFE) Pump F 12-015, 07-03, 05-05 & 05-07
FCO-PCB	Printed circuit board
FPV-PCB	Printed circuit board
60 Box F	Solenoid
70 Box F	Solenoid

V Series Pump Spares



V-RMK-J-E	Remake kit (PVDF+EPDM+CE) Pump V 20-01
V-RMK-J-V	Remake kit (PVDF+Viton+CE) Pump V 20-01
V-RMK-K-E	Remake kit (PVDF+EPDM+CE) Pump V 10-04, 04-08 & 10-10
V-RMK-K-V	Remake kit (PVDF+Viton+CE) Pump V 10-04, 04-08 & 10-10
VCO-PCB	Printed circuit board
VMS-PCB	Printed circuit board
60 Box V	Solenoid
70 Box V	Solenoid
80 Box V	Solenoid

H Series Pump Spares



H-RMK-A-E	Remake kit (PP+EPDM+CE) 4X8 Hose Pump H 20-01
H-RMK-A-V	Remake kit (PP+Viton+CE) 4X8 Hose Pump H 20-01
H-RMK-A-PVDF	Remake kit (PVDF+Viton+PTFE) 4X8 Hose Pump H 20-01
H-RMK-B-E	Remake kit (PP+EPDM+CE) 4X6 Hose Pump H 10-04 & 04-08
H-RMK-B-V	Remake kit (PP+Viton+CE) 4X6 Hose Pump H 10-04 & 04-08
H-RMK-B-PVDF	Remake kit Remake kit (PVDF+Viton+PTFE) Pump H 10-04 & 04-08
H-RMK-G-E	Remake kit (PP+EPDM+CE) 6X8 Hose Pump H 02-16
H-RMK-G-V	Remake kit (PP+Viton+CE) 6X8 Hose Pump H 02-16
H-RMK-G-PVDF	Remake kit (PVDF+Viton+PTFE) 6X8 Hose Pump H 02-16
HCO-PCB	Printed circuit board
HPV-PCB	Printed circuit board
75 Box H	Solenoid

G Series Pump Spares

G-RMK-B-V	Remake kit (PP+Viton+CE) Pump G 10-05
G-RMK-C-V	Remake kit (PP+Viton+CE) Pump G 10-10
G-RMK-D-V	Remake kit (PP+Viton+CE) Pump G 05-15 & 04-20
G-RMK-D-PVDF	Remake kit (PVDF+Viton+PTFE) Pump G 05-15 & 04-20
G-RMK-E-E	Remake kit (PP+EPDM+CE) Pump G 03-30 & 01-50
G-RMK-E-V	Remake kit (PP+Viton+CE) Pump G 03-30 & 01-50
G-RMK-E-PVDF	Remake kit (PVDF+Viton+PTFE) Pump G 03-30 & 01-50
G-RMK-F-E	Remake kit (PP+EPDM+CE) Pump G 00-100
G-RMK-F-V	Remake kit (PP+Viton+CE) Pump G 00-100
G-RMK-F-PVDF	Remake kit (PVDF+Viton+PTFE) Pump G 00-100
GCO-PCB	Printed circuit board
GPV-PCB	Printed circuit board
GMS-PCB	Printed circuit board
80 Box G	Solenoid
110 Box G	Solenoid

CMS Series Pump Spares from WATTCCON

CMS Series Pump Spares

CMS-RMK-B-E	Remake kit (PP+EPDM+CE) 4X8 Hose Pump CMS 25-05
CMS-RMK-B-V	Remake kit (PP+Viton+CE) 4X8 Hose Pump CMS 25-05
CMS-RMK-B-PVDF	Remake kit (PVDF+Viton+PTFE) 4X8 Hose Pump CMS 25-05
CMS-RMK-C-E	Remake kit (PP+EPDM+CE) Pump CMS 15-10
CMS-RMK-C-V	Remake kit (PP+Viton+CE) Pump CMS 15-10
CMS-RMK-C-PVDF	Remake kit (PVDF+Viton+PTFE) Pump CMS 15-10
CMS-RMK-D-E	Remake kit (PP+EPDM+CE) Pump CMS 07-20
CMS-RMK-D-V	Remake kit (PP+Viton+CE) Pump CMS 07-20
CMS-RMK-D-PVDF	Remake kit (PVDF+Viton+PTFE) Pump CMS 07-20
CMS-RMK-E-E	Remake kit (PP+EPDM+CE) Pump CMS 03-40
CMS-RMK-E-V	Remake kit (PP+Viton+CE) Pump CMS 03-40
CMS-RMK-E-PVDF	Remake kit (PVDF+Viton+PTFE) Pump CMS 03-40
CMS-RMK-F-E	Remake kit (PP+EPDM+CE) Pump CMS 02-60
CMS-RMK-F-V	Remake kit (PP+Viton+CE) Pump CMS 02-60
CMS-RMK-F-PVDF	Remake kit (PVDF+Viton+PTFE) Pump CMS 02-60
CMS-MF-PCB	Printed circuit board
115 Box CMS	Solenoid



Foot Valves

074.0166.1	Foot valve & strainer 3/8 " 4x6 (PP+Viton+CE)
074.0186.1	Foot valve & strainer 3/8 " 4x6 (PP+EPDM+CE)
074.0475.1	Foot valve & strainer 3/8 " 4x6 (PVDF+Viton+PTFE)
074.0144.1	Foot valve & strainer 3/8 " 4x8 (PP+Viton+CE)
074.0217.1	Foot valve & strainer 3/8 " 4x8 (PP+EPDM+CE)
074.0484.1	Foot valve & strainer 1/2 " 4x6 (PP+Viton+CE)
074.0496.1	Foot valve & strainer 1/2 " 4x6 (PP+EPDM+CE)
074.0492.1	Foot valve & strainer 1/2 " 4x6 (PVDF+Viton+PTFE)
074.0216.1	Foot valve & strainer 1/2 " 6x8 (PP+Viton+CE)
074.0185.1	Foot valve & strainer 1/2 " 6x8 (PP+EPDM+CE)
074.0477.1	Foot valve & strainer 1/2 " 6x8 (PVDF+Viton+PTFE)
074.0213.1	Foot valve & strainer 1/2 " 8x12 (PP+Viton+CE)
074.0198.1	Foot valve & strainer 1/2 " 8x12 (PP+EPDM+CE)



Injection Valves

073.0237.1	Injection valve 1/2 " 4x6 (PP+Viton+CE+C276)
073.0254.1	Injection valve 1/2 " 4x6 (PP+EPDM+CE+C276)
073.0511.1	Injection valve 1/2 " 4x6 (PVDF+Viton+PTFE+C276)
073.0218.1	Injection valve 1/2 " 4x8 (PP+Viton+CE+C276)
073.0256.1	Injection valve 1/2 " 4x8 (PP+EPDM+CE+C276)
073.0507.1	Injection valve 1/2 " 6x8 (PP+Viton+CE+C276)
073.0252.1	Injection valve 1/2 " 6x8 (PP+EPDM+CE+C276)
073.0234.1	Injection valve 1/2 " 6x8 (PVDF+Viton+PTFE+C276)
073.0481.1	Injection valve 1/2 " 8x12 (PP+Viton+CE+C276)
073.0198.1	Injection valve 1/2 " 8x12 (PP+EPDM+CE+C276)
073.0515.1	Injection valver1/2 " 8x10 (PVDF+Viton+PTFE+C276)



Hose Fitting Kit (Hose cone ring and nut)

025.0038.1	Hose fitting kit 3/8 " 4x6 Viton
025.0064.1	Hose fitting kit 3/8 " 4x6 EPDM
025.0039.1	Hose fitting kit 3/8 " 4x6 PVDF
025.0212.1	Hose fitting kit 1/2 " 4x6 Viton
025.0213.1	Hose fitting kit 1/2 " 4x6 EPDM
025.0230.1	Hose fitting kit 1/2 " 4x6 PVDF



Dosing Tanks, Storage Tanks & Bunds from WATTCCON

Dosing Tanks.



Robust moulded natural MDPE dosing tanks with black screw fitting lid with raised section to mount dosing pump, mixer and level sensors etc.

DT 50	50	Litre Dosing Tank Dia. 425 x H 500 mm
DT 100	100	Litre Dosing Tank Dia. 497 x H 698 mm
DT 200	200	Litre Dosing Tank Dia. 635 x H 782 mm
DT 300	300	Litre Dosing Tank Dia. 660 x H 1074 mm
DT 500	500	Litre Dosing Tank Dia. 815 x H 1100 mm
DT 1000	1000	Litre Dosing Tank Dia.1062 x H 1350 mm.

For black tanks add 10% to price

Bund Tanks



BT 25	25	Litre Dosing Tank Bund Dia. 680 x H 285 mm
BT 50	50	Litre Dosing Tank Bund Dia. 685 x H 288 mm
BT 100	100	Litre Dosing Tank Bund Dia. 806 x H 325 mm
BT 200	200	Litre Dosing Tank Bund Dia. 970 x H 400 mm
BT 300	300	Litre Dosing Tank Bund Dia. 940 x H 620 mm
BT 500	500	Litre Dosing Tank Bund Dia. 1130 x H 680mm
BT 1000	1000	Litre Dosing Tank Bund Dia. 1830 x H 1160mm

Sizes in natural MDPE with open top and rolled over top edge.

Note Tank & Bund prices are subject to change due to raw material price fluctuations.

Storage Tanks.



No longer supplied

Dosing Tanks Flooded Suction Kits

Tank mounting frame with a mounting for bracket for one F or V Series pump
For use solutions with a high viscosity or a low vapour pressure (hypochlorite)
Providing ease of priming and consistent dosing.

FSK 50	Stand for 50 L. tank & mounting for FCO pump.
FSK 100	Stand for 100 L. tank & mounting for FCO/GCO pumps.
FSK 200	Stand for 200 L. tank & mounting for FCO/GCO pumps.
FSK 300	Stand for 300 L. tank & mounting for FCO/GCO pumps.
MB-HP	Mounting bracket for HCO/HPV pump with bolts add
BV-TC	PVC Ball valve, tank connector & LDPE hose supplied loose.
DBV-TC	Dual ball valves & tank connectors for 2 pumps

Use one size larger bund when using pump flooded suction kits

Items supplied loose for assembly on site by your engineers.

Pump Mounting Bracket

Mounting bracket for mounting FCO/GCO pumps on dosing tanks.

TMBK-F	For use with F series dosing pumps
TMBK-G	For use with G series dosing pumps



Storage Tanks & Monitoring Instruments from WATTCCON



Storage Tanks

Robust seamless one piece vertical single wall chemical storage tanks moulded from black MDPE designed for ambient temperature solutions at atmospheric pressure with an SG of up to 1:2. Fitted with 600mm diameter hinged inspection manway, suitable for outdoor installation. Tanks are supplied plain for customers to fit their own fittings to suit their own site installation preference. Double skinned tanks, or tanks for higher SG solutions.

C 1800 1800 Litre Storage tank. Dia. 1400 x H 1500mm

C 2600 2500 Litre Storage Tank. Dia 1580 x H 1665mm

C 5500 5000 Litre Storage Tank. Dia 2000 x H 2173mm

C 10000 9400 Litre Storage Tank. Dia. 2200 x H 2173mm

Monitoring Instruments

For use with our storage tanks we are able to supply instruments for monitoring both solution temperature and liquid level. Our temperature sensors maybe installed from the tank top and are 316 SS and maybe fitted with a PTFE sheath for corrosive solutions.

Level sensors are either ultrasonic, for use with solutions with no foam or vapors or hydrostatic where ultrasonic cannot be used.

SRL-49 Panel mounted process meter with bar graph, LED display & level transducer power supply.
With 2 control relays and 4 - 20mA output.

SRL-73 Panel mounted process meter with LED display and level transducer ps
With 2 transducers

SRP-N118 Surf mounted w'proof process meter with LED display and level TPS

with 2 control relays

SWP-457 Surface mounted 57mm high LED display with built in level transducer power supplys

SWE-73T Panel mounted temperature meter with LED display
input Pt100, Pt500 or Pt1000

SRT-73 Panel mounted temperature meter with LED display input
Pt100, Pt500 or Pt1000
With 2 control relays

SRT-N118 Surface mounted w'proof temp meter with LED display input as above
With 2 control relays

Hand & Electric Mixers from WATTCCON



Hand Mixers

A

- HM-S Hand operated stumping mixer in PVC. with mounting flange.
- HM-R Hand operated rotating mixer in PVC. with mounting flange.
- BBP Four polypropylene nuts and bolts for mounting hand mixers

Electric Mixers High Speed

A

- MIXV10-2 Mixer with PVC mounting flange, shaft & propellor, fitted vapour seal and 240 volt motor for up to 400 litres capacity

Mixers with marine type propeller & shaft in 316 stainless steel.

- TM0 Mixer with 3" Ø propeller fitted 0.18 kW 415 volt motor
- TM0 - SP2 Mixer with 3" Ø propeller fitted 0.18 kW 240 volt motor
- TM1 Mixer with 4" Ø propeller fitted 0.37 kW 415 volt motor
- TM1 - SP2 Mixer with 4" Ø propeller fitted 0.37 kW 240 volt motor
- TM2 Mixer with 6" Ø propeller fitted 0.55 kW 415 volt motor
- TM3 Mixer with 7" Ø propeller fitted 0.75 kW 415 volt motor
- TM4 Mixer with 8" Ø propeller fitted 1.5 kW 415 volt motor

Electric Mixers Geared

- GMIX-1 Mixer with PVC sheathed shaft & impeller up to 250 litres with 65 RPM 240 volt motor/G-Box

Geared mixer with flat bladed impeller and shaft in 316 stainless steel

- GMW0 Geared mixer with 10" Ø impeller fitted 0.09 kW motor 415 volt

- GMW1 Geared mixer with 10" Ø impeller fitted 0.18 kW motor 415 volt
- GMW1-SP2 Geared mixer with 10" Ø impeller fitted 0.18 kW motor 240 volt
- GMW1-SP1 Geared mixer with 10" Ø impeller fitted 0.18 kW motor 110 volt

- GMW11 Geared mixer with 10" Ø impeller fitted 0.37 kW motor 415 vol
- GMW11-SP2 Geared mixer with 10" Ø impeller fitted 0.37 kW motor 240 vol
- GMW11-SP1 Geared mixer with 10" Ø impeller fitted 0.37 kW motor 110 volt

- GMW2 Geared mixer with 12" Ø impeller fitted 0.55 kW motor 415 vol
- GMW21 Geared mixer with 12" Ø impeller fitted 0.75 kW motor 415 vol

- GMW3 Geared mixer with 16" Ø impeller fitted 1.1 kW motor 415 vol
- GMW31 Geared mixer with 16" Ø impeller fitted 1.5 kW motor 415 vol

- GMW4 Geared mixer with 20" Ø impeller fitted 2.2 kW motor 415 vol
- GMW41 Geared mixer with 20" Ø impeller fitted 3.0 kW motor 415 vol

Strengthened Tank Tops

A

Dosing tanks which are to be fitted with dosing pumps and/or mixers require the top to be strengthened.

- PVC-MP-A PVC plate to hold the equipment. DT 50 - DT300
- PVC-MP-B PVC plate to hold the equipment. DT 500 - DT1000
- MSMB Mild Steel Bridge to hold the equipment. DT 300 - DT1000



Motor Driven Dosing Pumps & Accessories from WATTCCON

D Series

Mechanical diaphragm dosing pumps have adjustable stroke length control



Model No	L/Hr.	Bar	Strokes /Min	Motor Size
With PVC Heads and Valves				
D50N-50-13-B	0 - 49	10.0	116	0.18 Kw
D100N-70-13-C	0 - 124	5.0	96	0.18 Kw
D101N-105-13-C	0 - 275	3.0	96	0.25 Kw
D101N-120-13-B	0 - 408	3.0	120	0.25 Kw



Model No	L/Hr	Bar	Strokes /Min	Motor Size
With SS Heads and Valves				
D50N-50-11-B	0 - 49	10.0	116	0.18 Kw
D100N-70-11-C	0 - 124	5.0	96	0.18 Kw
D101N-105-11-C	0 - 275	3.0	96	0.25 Kw
D101N-120-11-B	0 - 408	3.0	120	0.25 Kw

A Series SS Heads

Stainless heads and valves with BSP connectors. Motors 400 volt three phase. **A series pumps have slow stroking speeds for dosing viscous non abrasive solutions, larger pumps available on request**



Model No	L/Hr	Bar	Strokes /Min	Motor Size
A125N-25-11-F	0 - 13.2	20.0	35	0.18 Kw
A175N-30-11-F	0 - 52.0	20.0	70	0.25 Kw
A175N-47-11-F	0 - 130.0	8.5	70	0.25 Kw
A250N-64-11-F	0 - 266.0	9.5	70	0.55 Kw

Standard motor is 380/415 volt 3 phase for 240 volt 0.18 Kw single phase motor (add)
 Standard motor is 380/415 volt 3 phase for 240 volt 0.25 Kw single phase motor (add)
 Standard motor is 380/415 volt 3 phase for 240 volt 0.55 Kw single phase motor (add)
 Ex D Three phase motor upto 0.55 Kw (add)
 Servo motor 24 volt supply for auto stroke control from 4 - 20 mA signal (add)



Loading / Pressure Relief Valves

Adjustable relief / safety valve 1 - 10 bar.
 Loading valve when dosing to an open end.
 Anti siphon valve when the dosing point is lower than the pump

- VSC-6N-P 1/2" BSP PVC Loading Valve 0 - 90 L/Hr
- VSC-10N-P 1/2" BSP PVC Loading Valve 0 - 230 L/Hr
- VSC-14N-P 3/4" BSP PVC Loading Valve 0 - 420 L/Hr
- VSC-24N-P 1" BSP PVC Loading Valve 0 - 1000 L/Hr

- VSC-6N-S 1/2" BSP Stainless Steel Loading Valve 0 - 90 L/Hr
- VSC-10N-S 1/2" BSP Stainless Steel Loading Valve 0 - 230 L/Hr
- VSC-14N-S 3/4" BSP Stainless Steel Loading Valve 0 - 420 L/Hr
- VSC-24N-S 1" BSP Stainless Steel Loading Valve 0 - 1000 L/Hr

Foot Valves

Foot valve for pumping with a suction lift from a chemical container.
 VFF6/14 PVC 3/8" BSP PVC Foot Valve 0 - 45 L/Hr
 VFF8/14 PVC 1/2" BSP PVC Foot Valve 0 - 220 L/Hr
 VFF13/14 PVC 3/4" BSP PVC Foot Valve 0 - 400 L/Hr
 VFF22/14 PVC 1" BSP PVC Foot Valve 0 - 1000 L/Hr

Injection Valves

Injection valve with built in NRV for dosing into pipes or vessels
 VI6-N/14 PVC 3/8" BSP PVC Injection Valve 0 - 45 L/Hr
 VI8-N/14 PVC 1/2" BSP PVC Injection Valve 0 - 220 L/Hr
 VI13-N/14 PVC 3/4" BSP PVC Injection Valve 0 - 400 L/Hr
 VI22-N/14 PVC 1" BSP PVC Injection Valve 0 - 1000 L/Hr

- VI6-N/11 STST316 3/8" BSP Stainless Steel Injection Valve 0 - 45 L/Hr
- VI8-N/11 STST316 1/2" BSP Stainless Steel Injection Valve 0 - 220 L/Hr
- VI13-N/11 STST316 3/4" BSP Stainless Steel Injection Valve 0 - 400 L/Hr
- VI22-N/11 STST316 1" BSP Stainless Steel Injection Valve 0 - 1000 L/Hr

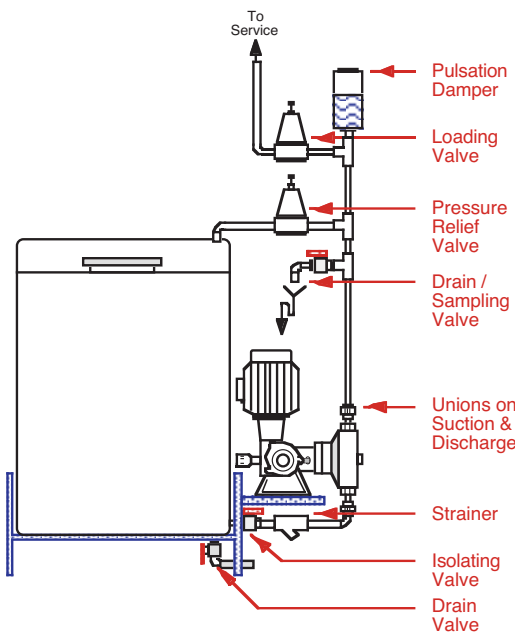

Solenoid and Control Valves from WATTCCON

Direct Operating Brass Solenoid Valves N/C

Solenoid valve for water, neutral liquid and gaseous media brass body with female BSP threaded ports. Standard diaphragms are NBR with FPM to order.



Part No	Size BSP.	Min PSI	Max PSI	Solution °C	Voltage
BSV-050-00	1/2"	0 PSI	90 PSI	90°C	24, 115, 230v AC
BSV-075-00	3/4"	0 PSI	90 PSI	90°C	24, 115, 230v AC
BSV-100-00	1"	0 PSI	90 PSI	90°C	24, 115, 230v AC

Pilot Operated Brass Solenoid Valves High Temp



BSV-050-05HT	1/2"	7 PSI	120 PSI	170°C	24, 115, 230v AC
BSV-075-05HT	3/4"	7 PSI	120 PSI	170°C	24, 115, 230v AC
BSV-100-05HT	1"	7 PSI	120 PSI	170°C	24, 115, 230v AC

Pilot Operated Brass Solenoid Valves N/C



BSV-050-05	1/2"	8 PSI	150 PSI	90°C	24, 115, 230v AC
BSV-075-05	3/4"	8 PSI	150 PSI	90°C	24, 115, 230v AC
BSV-100-05	1"	8 PSI	150 PSI	90°C	24, 115, 230v AC
BSV-150-05	1 1/2"	8 PSI	150 PSI	90°C	24, 115, 230v AC
BSV-200-05	2"	8 PSI	150 PSI	90°C	24, 115, 230v AC

Brass Solenoid Valve Three Port.

Three port brass bodied solenoid valve use as a pilot valve to operate the air to a pneumatic valve.



BSV-025-3PT	1/4"	0 PSI	120 PSI	90°C	24, 115, 230v AC
-------------	------	-------	---------	------	------------------

Plastic Solenoid Valve Normally Closed.

Servo operating Plastic bodied solenoid valve with internal components in stainless steel



PSV-075-03	3/4" male	3 PSI	90 PSI	60°C	24, 115, 230v AC
------------	-----------	-------	--------	------	------------------

Pneumatic Valves Fail Safe to Close.

Pneumatic dosing valve with plastic body and PTFE seals for chemical use requires pilot valve



PDV050	1/2"	0 PSI	50 PSI	40°C	Pneumatic
PDV075	3/4"	0 PSI	50 PSI	40°C	Pneumatic
PDV100	1"	0 PSI	50 PSI	40°C	Pneumatic
PDV150	1 1/2"	0 PSI	50 PSI	40°C	Pneumatic
PDV200	2"	0 PSI	50 PSI	40°C	Pneumatic

Pneumatic valve with bronze body and PTFE seals for neutral liquid and steam requires pilot valve

BPV075	3/4"	0 PSI	150 PSI	120°C	Pneumatic
BPV100	1"	0 PSI	150 PSI	120°C	Pneumatic

Three port pneumatic diverter valve with bronze body and PTFE seals requires pilot valve.



3PBPV100	1"	0 PSI	150 PSI	120°C	Pneumatic
3PBPV150	1 1/2"	0 PSI	150 PSI	120°C	Pneumatic
3PBPV200	2"	0 PSI	150 PSI	120°C	Pneumatic

Transfer Pumps & Accessories from WATTCCON

Double Diaphragm Pneumatic Pumps

Our double diaphragm pneumatic pumps are manufactured in 4 sizes for pumping liquids and slurries.

The body is moulded in polypropylene and fitted with either nitrile or PTFE diaphragm allowing a wide range of products to be pumped.

The pump range in sizes from 1/2" to 2", the output maybe adjusted by varying the air supply pressure to the pump.



Model No	Body	Diaphragm	Size Liquid	Size Air	Max output.	Weight
E5PP-E	PP	Nitrile	1/2" Threaded	3/8"	53 L/Min.	4.6 Kg
E5PP-T	PP	PTFE	1/2" Threaded	3/8"	53 L/Min.	4.6 Kg
E1PA-E	PP	Nitrile	1" Flanged	3/8"	132 L/Min.	10.9 Kg
E1PA-T	PP	PTFE	1" Flanged	3/8"	132 L/Min.	10.9 Kg
E4PA-E	PP	Nitrile	1 1/2" Flanged	1/2"	265 L/Min.	18.6 Kg
E4PA-T	PP	PTFE	1 1/2" Flanged	1/2"	265 L/Min.	18.6 Kg
E2PA-E	PP	Nitrile	2" Flanged	1/2"	586 L/Min.	33.0 Kg
E2PA-T	PP	PTFE	2" Flanged	1/2"	586 L/Min.	33.0 Kg.

Peristaltic Pump

For very simple intermittent dosing applications where a reagent is required to be dosed from a chemical drum into an open vessel or sump where no pressure is required to pump the chemical reagent peristaltic pumps offer a cost effective solution.



LRP

Simple peristaltic pump output 3.0 L/Hr not continuous supply 240 VAC
 Supplied in batches of 5 price each
 Supplied in batches of 10 price each
We have limited stocks of this pump hence the special price



MP2

Simple peristaltic pump output 6.0 L/Hr using 5 mm Ø silicone tubing or 2.4 L/Hr using 3mm Ø noreprene tubing built in dose & delay timer supply 240 VAC
 Supplied in batches of 5 price each
 Supplied in batches of 10 price each



Discontinued



Discontinued

Wattccon
20 Ali Akilu Road
(Zadina Plaza)
PO Box 8808, Kaduna
Nigeria

Tel: 234.62.213585
Fax: 234.62.213585
E-mail: info@wattccon.com

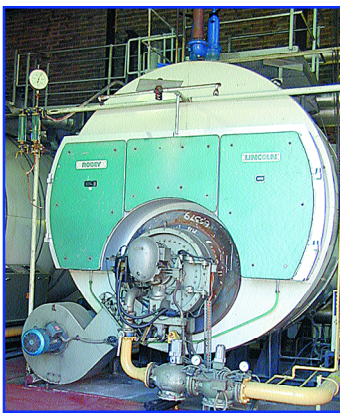

Telephone WATTCCON on 234.62.213585 or e-mail info@wattccon.com